

**DECORAPORT<sup>®</sup> LED MIRROR**

**LIT UP YOUR BEAUTY**

(The Manual of LED Bathroom Mirror)

**TOOLS**



ELECTRIC DRILL

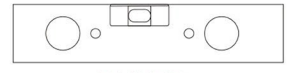

RULER



HAMMER

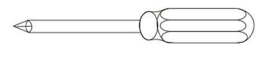

+ SCREWDRIVER

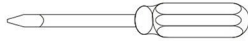

- SCREWDRIVER

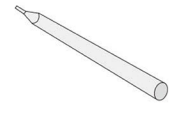

PENCIL



TAPE MEASURE

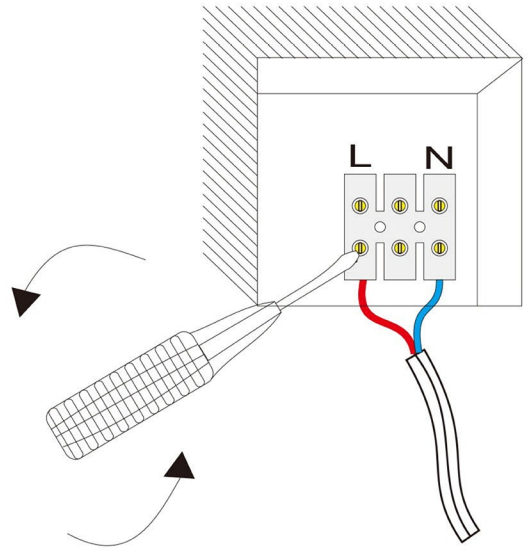
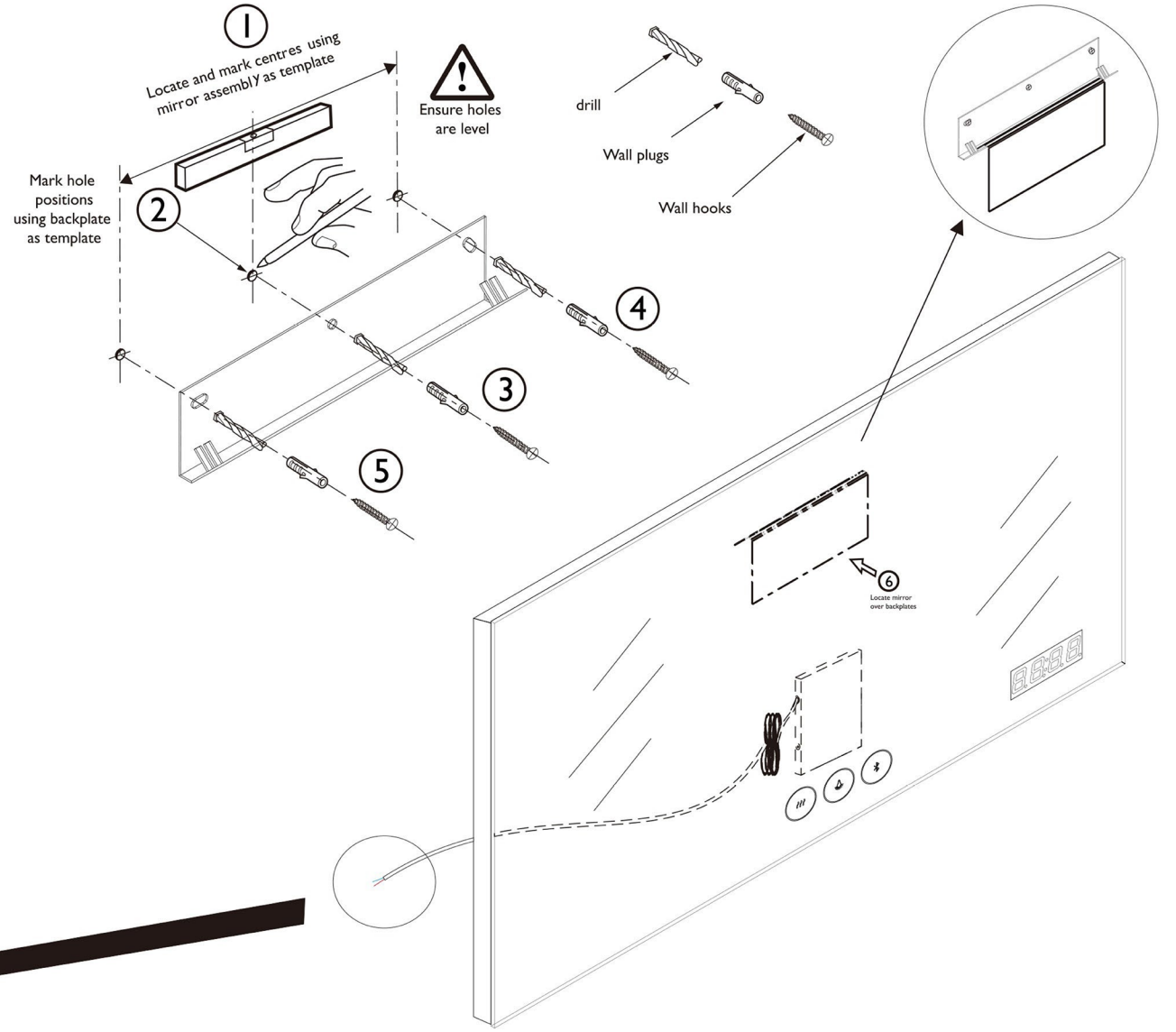

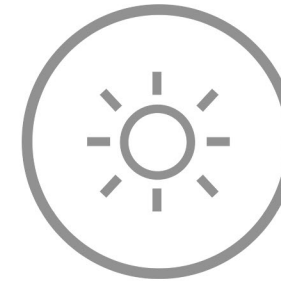
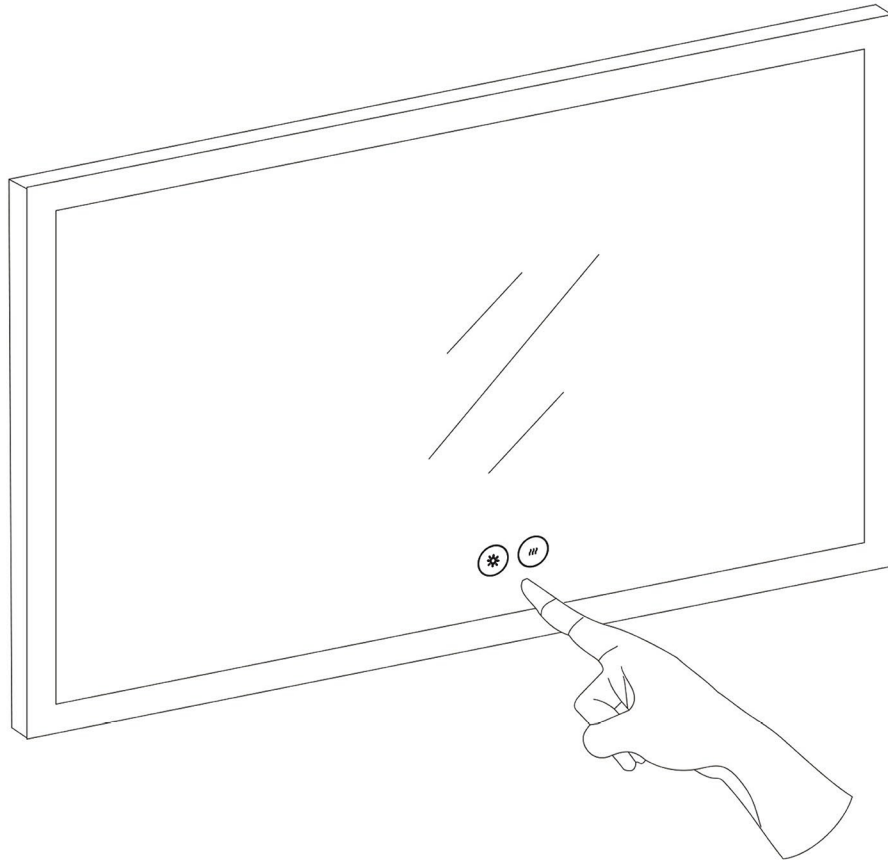

**1. Installation**

## 2. Dimmer



On/Off & Dimmer

Press the button  , the button will change from red to blue, and the light is On. Press the button  again, the button will change from blue to red, and the light is Off.

Press the button  for 3 seconds, the light will be adjusted from 100% to 10%. Press the button for another 3 seconds, the light will be adjusted from 10% to 100%.

Brightness

100%



50%

10%

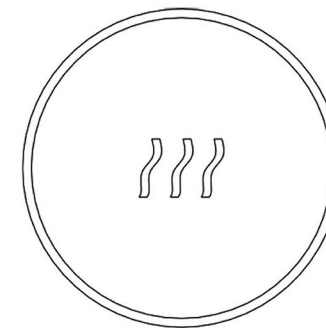
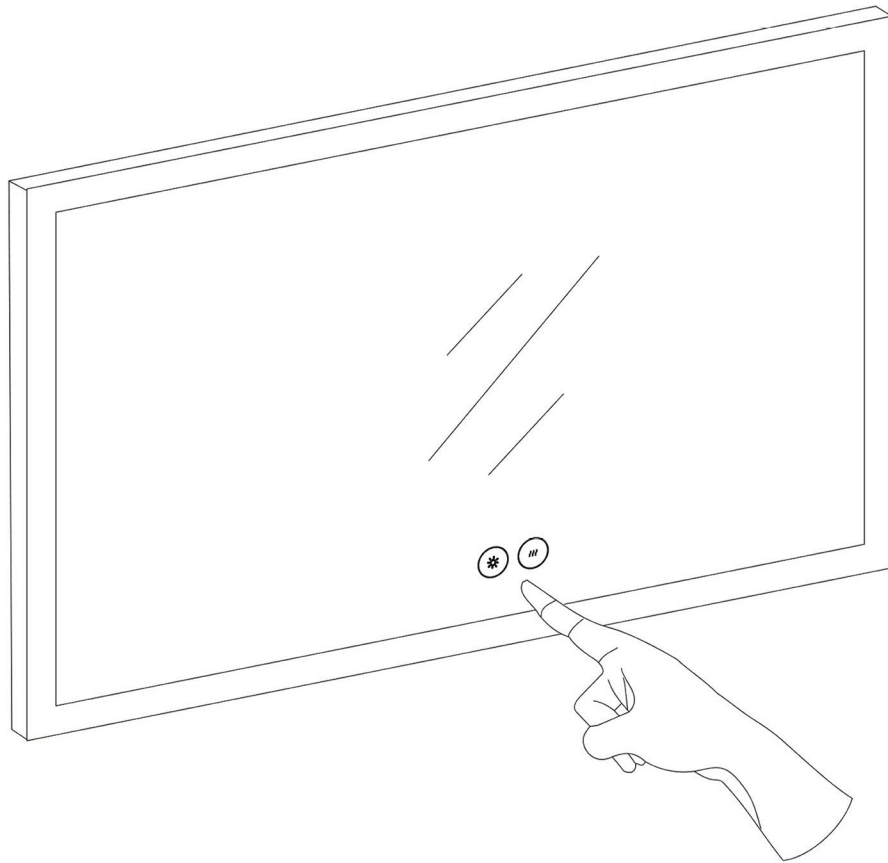
### 3. Anti-fog



Anti-Fog

Press the button , the button will change from red to blue, and the anti-fog is On. Press the button  again, the button will change from blue to red, and the anti-fog is Off.

## 4. Mirror & Wall Control



Our mirror controller has the memory function which can memorize the final status of:

1. The light on or off.
2. The light brightness.
3. The light temperature.
4. The anti-fog on or off.

Turn on the mirror light and keep it on, and then you can control it by the switch on the wall.

## 5.Adjustable Lights(Optional)

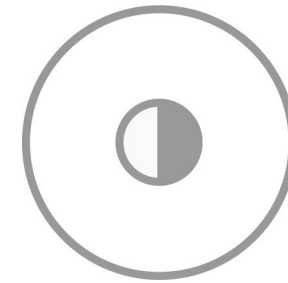
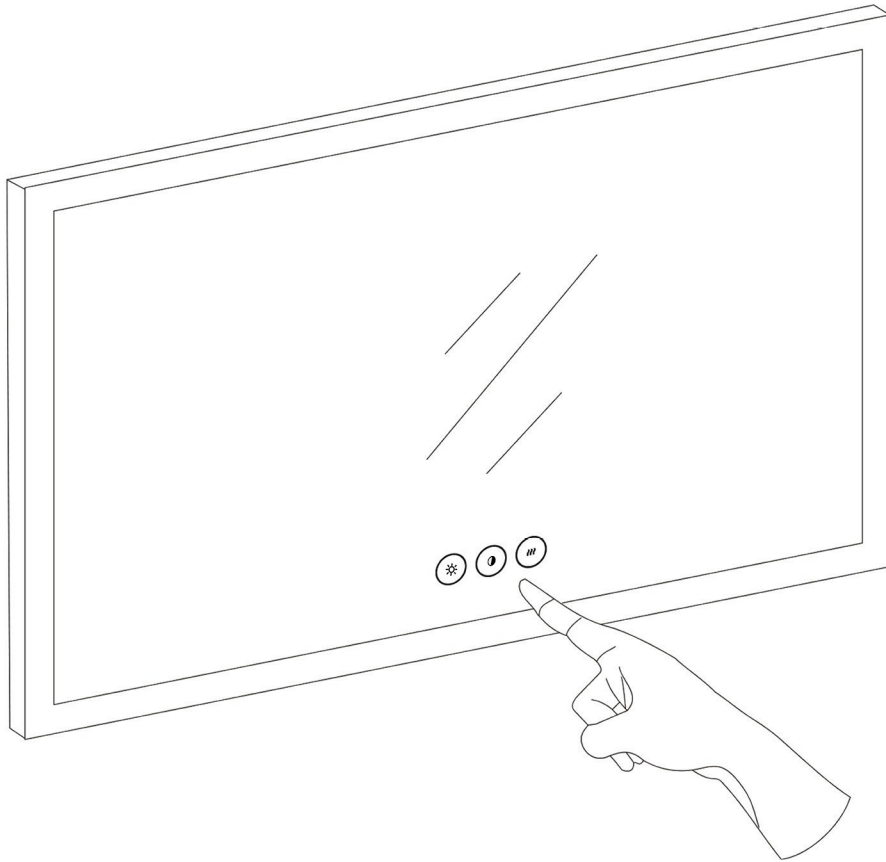

Adjustable Lights

The light of the mirror could be switched among cold white light(6000K), natural light(4000K) and warm white light(3000K).

## 6. Bluetooth (Optional)

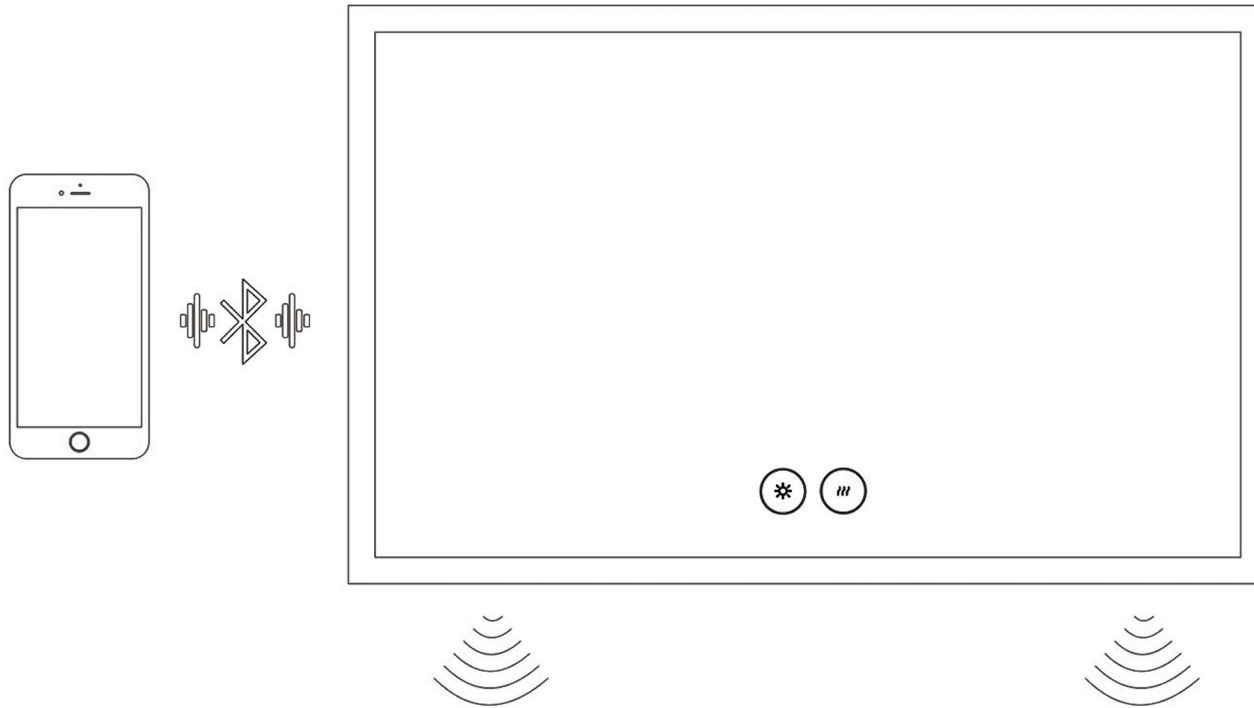

The two bluetooth speakers will be activated after the electricity is on.  
And you could use smartphone or tablet PC to connect with them to play music.

## 7. Magnifier(Optional)

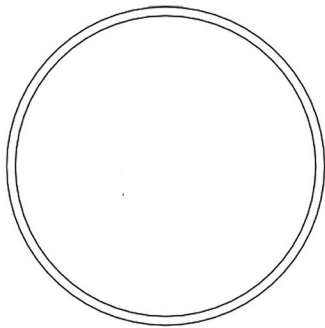
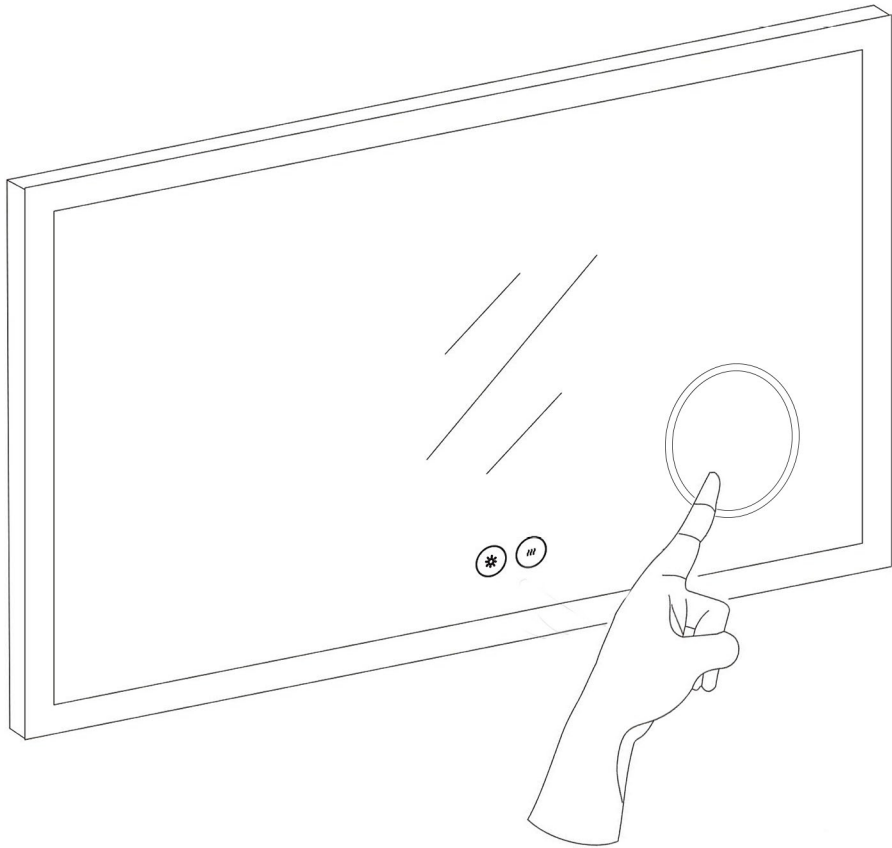

Magnifier

The magnifier is 6.3 inches in diameter; 3 times magnification; with LED lights.



# Notice:

- 1) For indoor use only.
- 2) if the external flexible cable or cord of this luminaire is damaged, it shall be exclusively replaced by the manufacturer or his service agent or a similar qualified person in order to avoid a hazard.
- 3) The light source of this luminaire is not replaceable; when the light source reaches its end of life the whole luminaire shall be replaced.

